

Product Specifications

25 kV 600A Deadbreak Connecting Plug

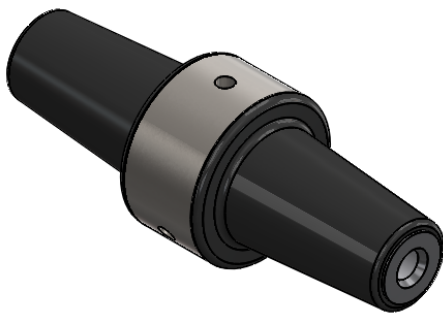
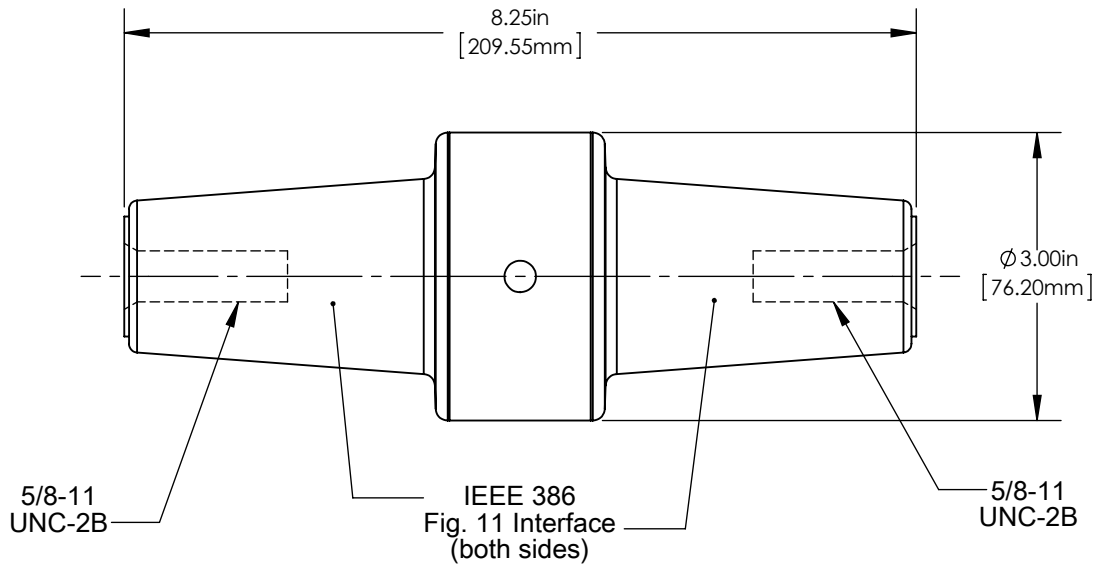

Richards 25 kV 600A Deadbreak Connecting Plug (P625CP) connects two or more 25 kV Deadbreak Elbows as a separable cable joint or directly to an apparatus bushing.

The connecting plug is fully shielded and features a standard bolted connection per IEEE Std. 386 Fig. 11 with an internal 3/8" hex or spanner wrench holes for installation.

Add -LS to include loose stud (P625CP-LS)
Add -S to include factory installed stud (P625CP-S)

Product Ratings

Operating Voltage	16.2 kV L-G 28 kV L-L
Impulse Withstand	140 kV BIL
AC Withstand	45 kV
DC Withstand	84 kV
Partial Discharge	22 kV CEV
Momentary	25 kA, 10 cycles
Continuous Current	600 Amp

Richards 25 kV 600A Deadbreak Connecting Plug (P625CP) was designed and validated against the following industry standards:

- ANSI/IEEE Std. 386: For Separable Insulated Connector Systems
- ANSI C119.4: For Electric Connectors
- IEEE Std. 592: For Exposed Semiconducting Shields